

ALDES SELECTS THE BEST SOLUTIONS FOR YOUR PROJECTS

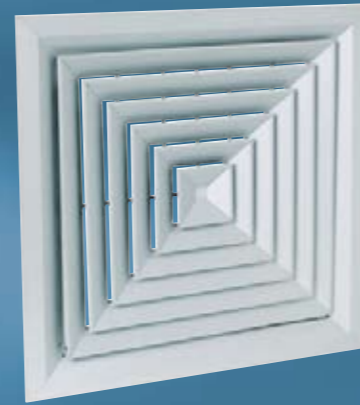

SF/SN 704S RREI
AF/AN 704S RREI

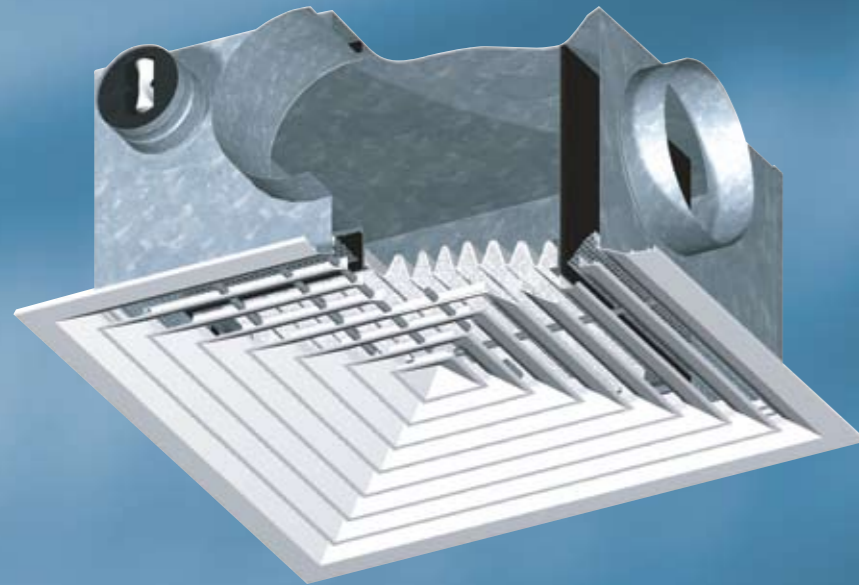
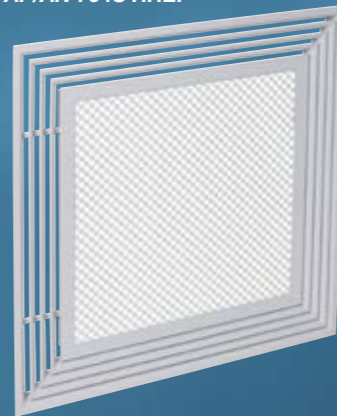

ALD 610K

Airflow comfort level for SF/SN 704S RREI - AF/AN 704S RREI

Comfort airflow levels for LW < NR 35 and dimensions

Model	A x B (mm)	L x H (mm)	l x h (mm)	H (mm)	Ø D1 (mm)	Airflow (m³/hr)
AF/SF 704S R REI	600 x 600	472 x 472*	323 x 323	355	250	500
AN/SN 704S R REI	600 x 600	525 x 525*	375 x 375	420	315	650
AN/SN 704S R REI	675 x 675	600 x 600**	375 x 375	420	315	850

Airflow comfort level for ALD 610K

Comfort airflow levels for LW < NR 35 and dimensions

A x B (mm)	N° slots	P x P (mm)	V x V (mm)	H1 (mm)	H2 (mm)	G (mm)	Ø D1 (mm)	Airflow (m³/hr)
600 x 600	1	504 x 504	560 x 560	260	130	25	200	300
600 x 600	2	470 x 470	560 x 560	310	130	42	250	500
600 x 600	3	436 x 436	560 x 560	310	130	59	250	750
600 x 600	4	402 x 402	560 x 560	310	130	76	250	900
675 x 675	1	579 x 579	635 x 635	260	130	25	200	350
675 x 675	2	545 x 545	635 x 635	310	130	42	250	550
675 x 675	3	511 x 511	635 x 635	310	130	59	250	850
675 x 675	4	477 x 477	635 x 635	310	130	76	250	1000

COMBINED DIFFUSER

THE PERFECT COMBINATION

ALDES MIDDLE EAST

Sharjah Office Tel: +971 6 5578285
Fax: +971 6 5578405

Abu Dhabi Office Tel: +971 2 6436794
Fax: +971 2 6436715

www.aldes.ae



aldes air&people
euroregister



Combined air supply & air exhaust

Only one diffuser to ensure both air supply and air exhaust functions. Supply is ensured in periphery and exhaust diffuser from the center. No more constraints for the exhaust positioning in any rooms!

Combined comfort & energy saving

The combination of 2 functions into one product prevents any by-pass problem leading to 30-40% of energy saving.

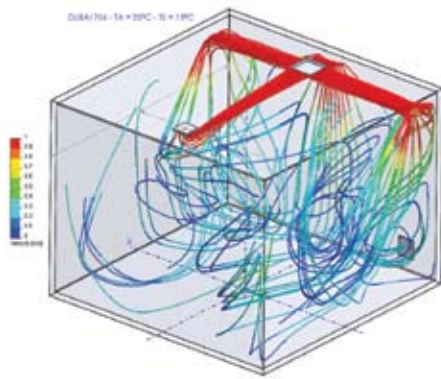

Bad installation with by-pass effect

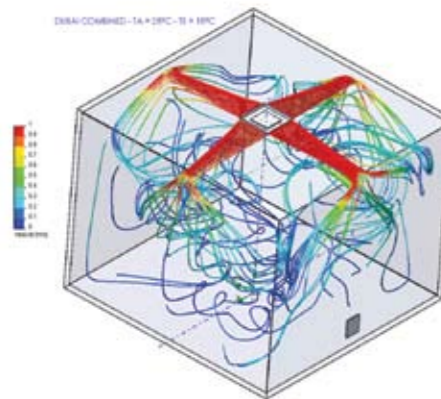

Combined solution

Combined comfort & design

Combined diffuser is noiseless and offers a perfect comfort from 300 to 1000m³/h. With only one diffuser instead of two, the visual impact on the ceiling is minimized. Aldes range offers 2 different aesthetics for this solution: the perfect combination between comfort and design.

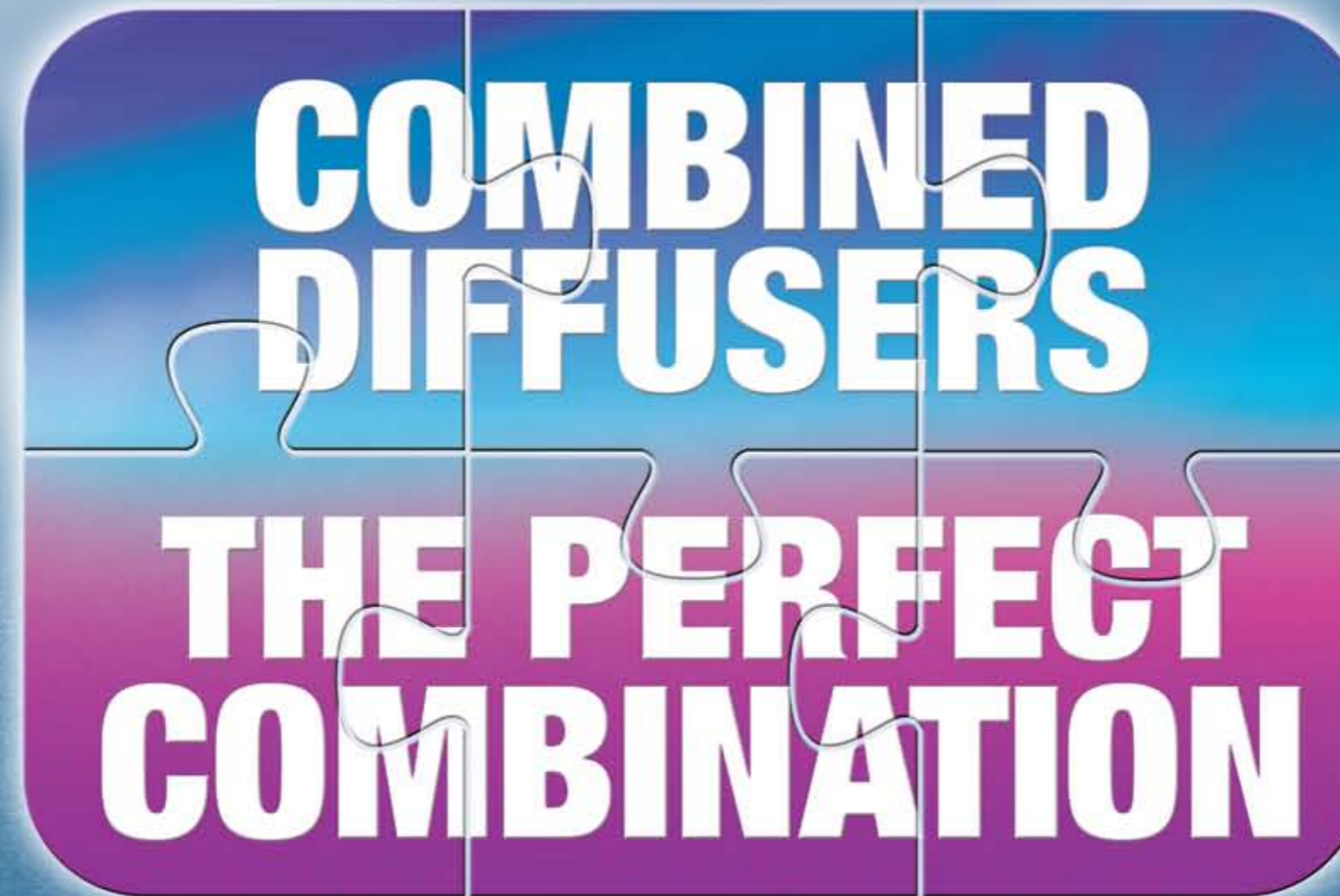
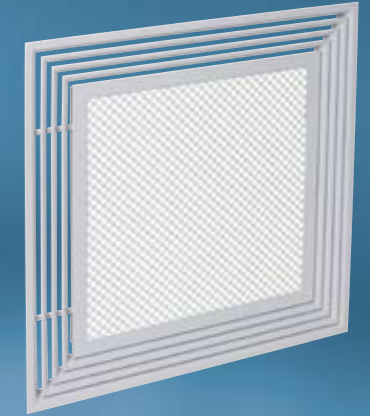
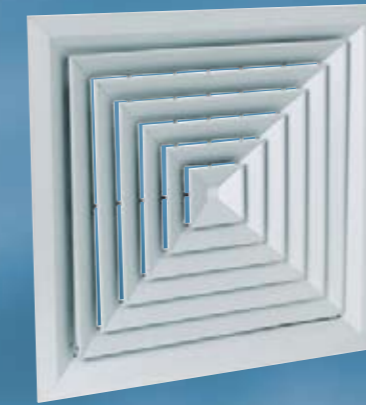

Combined performance & easy installation

Combined is also the perfect combination in terms of installation with 40% of time saving:

- Only 1 diffuser to install instead of 2: no problem of space restriction
- Delivered with plenum to ease the ductwork connection and guarantee performances
- Easy maintenance

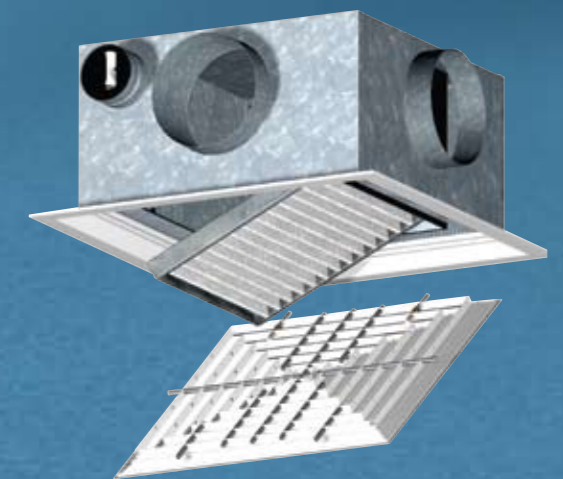

Combined air diffusion & existing systems

Combined diffuser is ideal with heat-recovery ventilation systems, air handling units or standard convector fans.

Combined European expertise & proximity with a local partner

With Combined diffuser, you enjoy the expertise and knowledge from a European air diffusion expert, as well as the close relationship with our offices and factory in the UAE.